

**EUROPLÁSTICOS®**

[www.europlasticosexposito.es](http://www.europlasticosexposito.es)



0,2 l  
A/001/001



0,5 l  
A/001/017



1 l  
A/001/026

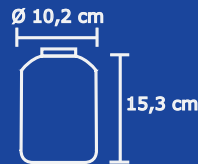

1 l  
A/001/002

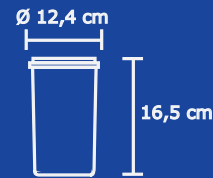

1,5 l  
A/001/003

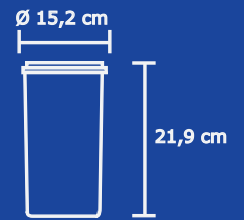

3 l  
A/001/004

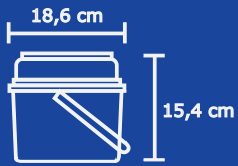

3 l  
A/001/005  
A/001/018

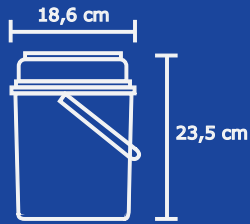

5 l  
A/001/006  
A/001/019

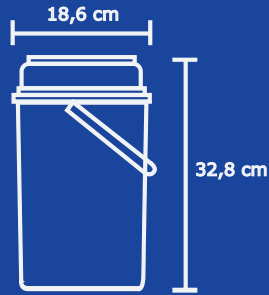

7 l  
A/001/024  
A/001/025

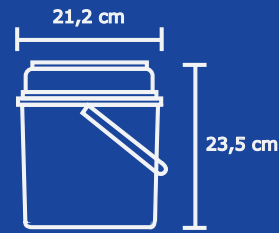

10 l  
A/001/007  
A/001/016  
A/001/028

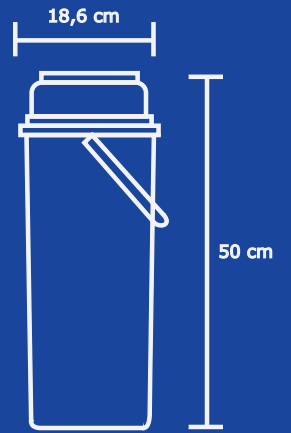

12 l  
A/001/008  
A/001/020

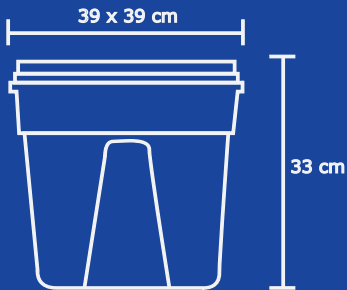

30 l  
A/001/009

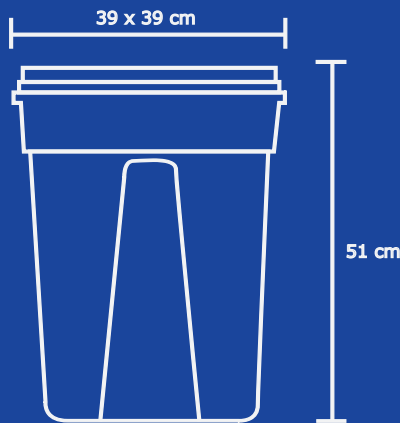

50 l  
A/001/023

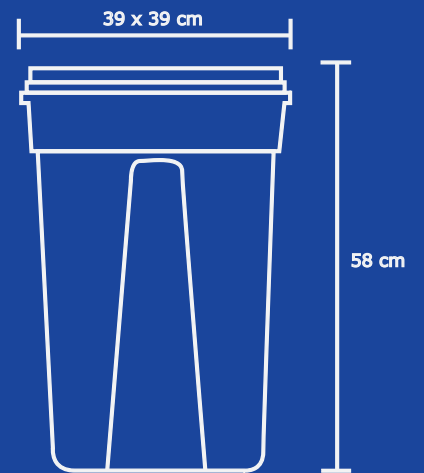

60 l  
A/001/010

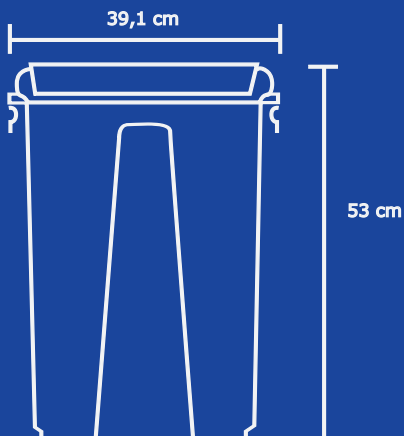

40 l  
A/001/027

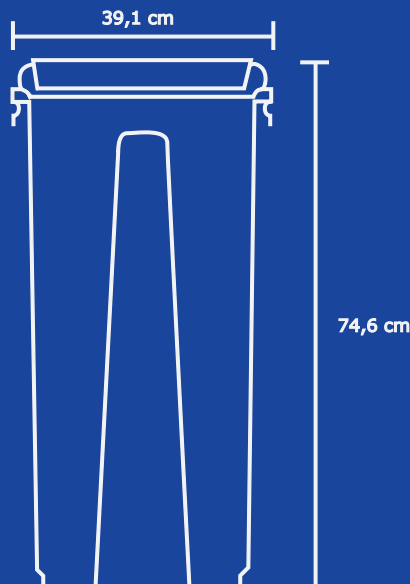

60 l  
A/001/011

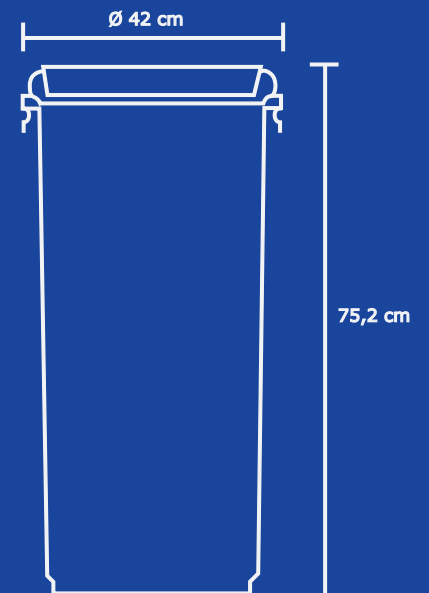

60 l  
A/001/012

# CONTENEDORES PARA PUNZANTES

Contenedores de uso único diseñados para el transporte y acondicionamiento de residuos hospitalarios peligrosos o de cualquier otro tipo de residuo de alto riesgo, como por ejemplo, materiales cortantes, perforantes o contundentes. Sus características son:

- Fabricados con materiales de gran resistencia.
- Imperforables, resistentes a la perforación, tanto interna como externa.
- Opacos, impermeables y resistentes a la humedad.
- Hendiduras y muescas en la tapa para facilitar la extracción de las agujas.
- Apilables.
- Su destrucción por combustión no genera emisiones tóxicas.



A/001/001 A/001/002



A/001/004

A/001/003

## 1a Generación

## 1st Generation



A/001/024



A/001/006



A/001/007



A/001/008

A/001/005

# SHARP CONTAINERS

Single use container designed for the transport and upgrading of hazardous hospital waste or other high risk waste, such as cutting, penetrating or blunt materials.

Its features are:

- Made with high strength materials.
- Impossible to penetrate and resistant to puncture, both internal and external.
- Opaque, waterproof and resistant to dampness.
- Grooves in the lid to facilitate removal of the needles.
- Stackable (except 12 litres).
- Destruction by burning doesn't generate any toxic emissions.



## 2a Generación 2nd Generation



A/001/016

## 3a Generación 3rd Generation



A/001/028



A/001/025

A/001/019



A/001/020

A/001/018



A/001/023

A/001/010

A/001/009

# MEDICAL WASTE CONTAINERS

# CONTENEDORES RESIDUO SANITARIO



A/001/027

A/001/011

A/001/012

AENOR AENOR



Empresa  
Registrada  
ER - 320/2005

Gestión  
Ambiental  
GA - 2010/522



# EUROPLÁSTICOS®

[www.europlasticosexposito.es](http://www.europlasticosexposito.es)  
[info@europlasticosexposito.es](mailto:info@europlasticosexposito.es)

Europlásticos Expósito, SL  
Pol. Ind. Casa Pau  
C/ Granada, 15  
(Apartado de Correos 203)

Telf: +34 96 555 45 01  
Fax: +34 96 555 48 61

 03440 Ibi (Alicante)